



---

**AVR Lexion System**

**LUD48 driver unit**

---



## Specifications

---

Unit type: Switch mode constant current LED driver

Outputs: 4 dimmed outputs 0-350mA per output, 48 volt

Input: AC 80V-260V 50-60Hz 0.6A

Control: DMX512 or internal control

Protection: LED outputs protected against short circuit and miswiring. Driver protected by progressive thermal shutdown.

AbstractAVR Ltd  
Rear of 24/26 Leicester Road  
Blaby  
Leicester  
LE8 4GQ  
Tel: 0116 278 8078  
[www.avr.uk.com](http://www.avr.uk.com)

## About this unit

---

The LUD48 is an LED driver for the AVR Ledion system. It can drive up to 48 one-watt LED emitters in 4 channels, 12 per channel. So for example it could drive the following:

12 LU3 or LU4 fixtures

6 LU6 fixtures

1 LUS1200/36 batten

The LEDs may be controlled from DMX512, or from the unit's on board programs.

Multiple units may be linked up by DMX512, or in a stand-alone master-slave configuration.

The LUD48 is configured using an letter/number display system with pushbuttons.

The LUD48 is fully protected against short circuits on its LED output.

---

## Connecting it up

---

The power cable of the unit should be connected to AC mains, 80-260V, 50-60Hz.

If the unit is installed, ensure there is clear airflow around the unit for cooling, or it may overheat and shut down.

There are three control sockets.



The DMX sockets (in and link through) or for master-slave linking of units. Pin 1 is the leftmost pin in the above picture.

➤ Warning: Although this unit uses similar connectors to a computer network, it is not compatible. Network equipment may be damaged if you connect this unit to a computer network.

DMX pins: Pin 1=Data Hot, Pin 2=Data Cold, Pin 8=Ground  
RJ45 viewed from contact side

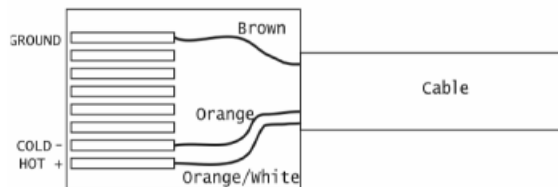

---

## Status displays

---

In DMX mode the display shows

The \_ is replaced by a rotating circle if DMX is being received.

In standalone playback mode the display shows

(1 is the pattern number). This display also shows if Macro playback is selected by DMX.

If the unit starts to get too hot, it will reduce output power to protect itself and the LED fixtures. The display shows



(Reduced POver)

If the unit passes its safe operating temperature it will shut down.

The display shows

The unit will enter a cooling period and will restart once the temperature has fallen.

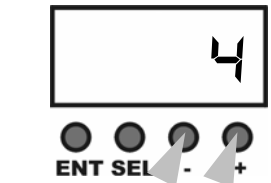
To enter the menu system hold the ENT button (above the \_)

	<p>Keep pressing the ENT button to get to the LOAD option.</p>
	<p>Use the + and - buttons to set the number to match the number of LEDs connected.</p>
	<p>Press the ENT button to store the LOAD setting.</p>

The LED fixtures link to the LED socket. Multiple fixtures can be connected using the LUT tee-piece.

All fixtures should be connected to the LUD48 power supply with RJ45 data cables into the LUT (tee piece). The fixture is plugged into the port marked LED, the cable coming from the LUD48 is plugged into the port marked IN and the cable to the next fixture is plugged into the port marked OUT.

When you come to the last fixture an LUC/EL should be used in place of the tee as you do not need to carry on to any other fixtures. The LUC/EL can be used for the end of the line or as an in line connector to extend data cables.

➤ Note: All tee-piece sockets must have either a fixture or another tee-piece connected – if there are any open sockets in tee-pieces, none of the fixtures will light.

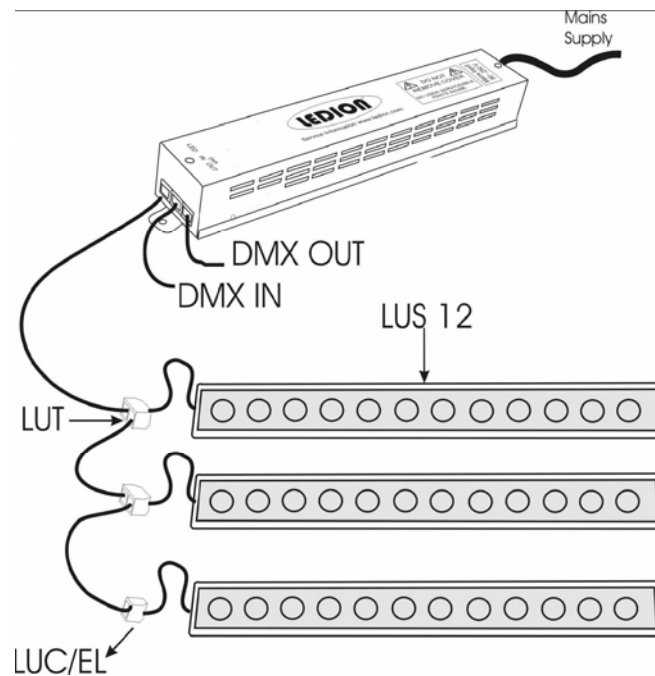

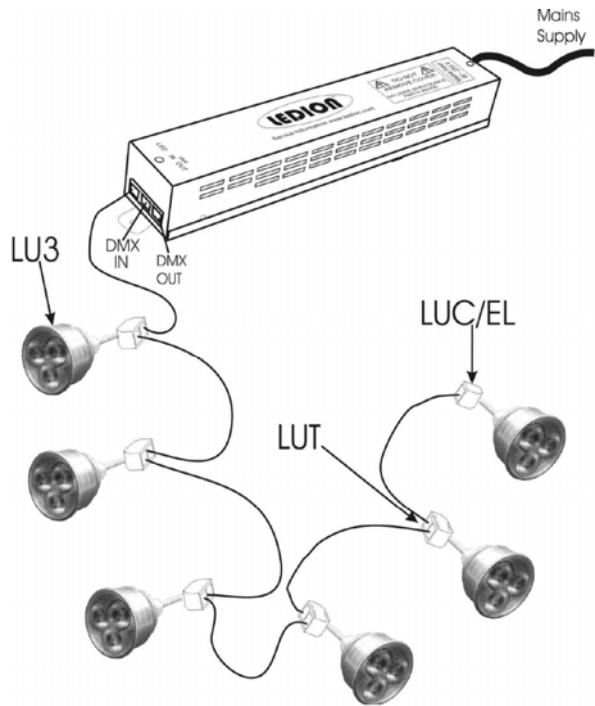

LED cable wiring: Pins 1-4=Common positive, pin 5=Red neg, pin 6=Green neg, pin 7=Blue neg, pin 8=White neg.

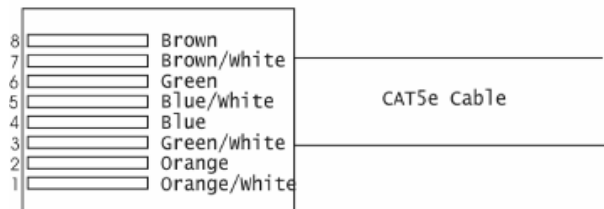

## Other configuration

### Option Clear to factory defaults

Resets all options and patterns to factory defaults when you press the right hand button. This will erase any patterns you have programmed.

<p>The display shows 'OPCL' in a 7-segment font. Below the display are four buttons: 'ENT SEL', '-', and '+'. An arrow points to the 'ENT SEL' button.</p>	<p>Keep pressing the ENT button to get to the OPCL option.</p>
<p>The display shows 'WAIT' in a 7-segment font. Below the display are four buttons: 'ENT SEL', '-', and '+'. An arrow points to the '+' button.</p>	<p>Press the + button. The display will show WAIT while the memory is cleared.</p>

### Configure LED Load

This allows you to fine tune the operation of the driver for the LED load. At very low LED intensities the brightness will vary slightly depending on how many LEDs you connect, so a driver with a 36-LED load will be slightly dimmer than another driver with a 12 LED load.

If you need to match drivers with different loads, set this option to the number of LEDs of each colour you have got connected (e.g. if there are 4 of each colour LED, set the option to 4). This will help the matching, though it may be impossible to match exactly.

➤ Important: When using Stand Alone mode, ensure that the MACR option on all units is set to OFF. If MACR is ON, the stand alone control channels may trigger the macro mode.

## Operating the LUD48



### Test operating mode

When the unit powers up for the first time, or after being reset to factory defaults, it runs a simple option system intended for initial setup testing. The Test Mode setting is remembered after a power off.

Press ENT to change to the next option.

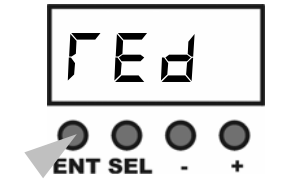
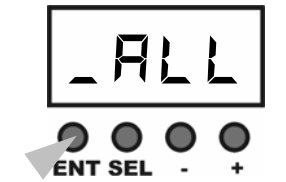
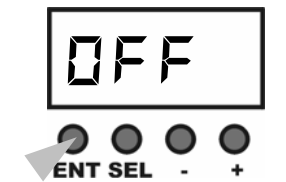
➤ TEST mode does not operate when DMX is present. To use TEST mode ensure all DMX is disconnected.

	<p>Runs a simple R-G-B fade (if the user changes the PATT settings then TEST will run this pattern instead- this can also be useful for setting an emergency fall-back program)</p>
	<p>RED / GRN / BLU / ORNG / CYAN / PURP/ WHIT: sets these colours. The + and – buttons can be pressed to change the intensity of the colours.</p>
	<p>ALL: turns on all LEDs</p>
	<p>OFF: turns everything off</p>

 <p>The image shows a digital display with the text 'SND'. Below the display are four buttons: 'ENT SEL', a minus sign, a plus sign, and a fourth unlabeled button. An arrow points to the 'ENT SEL' button.</p>	<p>SND: Runs a simple R-G-B fade (or the user selected PATT setting if the user has changed it), sound triggered</p>
 <p>The image shows a digital display with the text 'RAND'. Below the display are four buttons: 'ENT SEL', a minus sign, a plus sign, and a fourth unlabeled button. An arrow points to the 'ENT SEL' button.</p>	<p>RAND: Runs a random pattern, sound triggered</p>

Hold down any button for 3 seconds to get to the normal mode.



Once you are in normal mode, the unit will bypass the test mode on startup. To re-enable the test mode, select the TST option from the menu system.

If DMX is received while the unit is in Test mode, then it will switch to DMX mode. If DMX is lost, it will revert to Test mode.

There is no master-slave operation in Test mode.

### Macro control mode

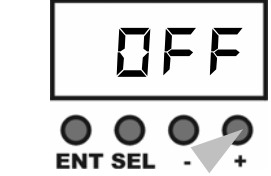
Macro mode allows you to activate the internal patterns from DMX.

 <p>The image shows a digital display with the text 'MACR'. Below the display are four buttons: 'ENT SEL', a minus sign, a plus sign, and a fourth unlabeled button. An arrow points to the 'ENT SEL' button.</p>	<p>Keep pressing the ENT button to get to the MACR option.</p>
 <p>The image shows a digital display with the text 'OFF'. Below the display are four buttons: 'ENT SEL', a minus sign, a plus sign, and a fourth unlabeled button. An arrow points to the plus sign button.</p>	<p>Use the + button to set macro On or Off. Default is Off.</p>
 <p>The image shows a digital display with the text 'SEL'. Below the display are four buttons: 'ENT SEL', a minus sign, a plus sign, and a fourth unlabeled button. An arrow points to the 'ENT SEL' button.</p>	<p>Press the ENT button to store the macro mode.</p>

When MACR is ON, an additional DMX channel is used to trigger macro mode – No macro below 50%, macro activated above 50%.

Note that if multiple units are controlled in Macro mode, the patterns are not synchronised and they may not change in time with each other if left running for long periods. We recommend that you change the pattern every hour or so to keep the units synchronised.

Also note that each unit will play back its own patterns, so if synchronisation is required, all units must be programmed with the same patterns.

In Macro mode, DMX channel 1 selects pattern 1-8, channel 2 selects step time and channel 3 selects crossfade (see p23 for values).



## Control mode

Sets the control mode for the unit – you can either control each channel individually or use the colour mix mode (HSL).

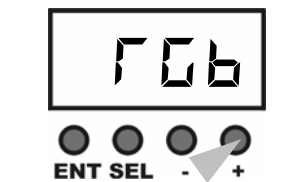
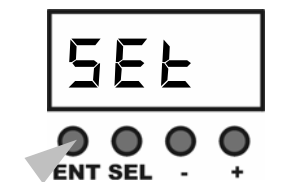
	<p>Keep pressing the ENT button to get to the MODE option.</p>
	<p>Use the + button to set the control mode. Modes are listed below.</p>
	<p>Press the ENT button to store the control mode.</p>



The available options, selected using the right hand button, are



- RGBD – individual control of each channel with overall master dimmer.
- RGB – default – individual control but no master dimmer
- HSL (hue, saturation, luminance – colour mix mode. Hue sets the colour from all available colours in the spectrum. Saturation sets the strength of the colour, from full colour at the bottom, through pastel colours, to white at the top. Luminance sets the brightness (dimmer control) for the colour.
- SNGL – all outputs are controlled by a single DMX channel. Used when single-colour fixtures are being controlled. Uses one DMX channel only.

## Stand alone operation

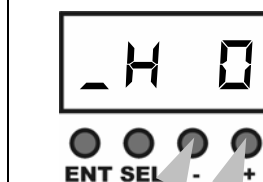
	<p>Hold down the SEL button to get into the Stand Alone options</p>
---	---

## Output a Static colour

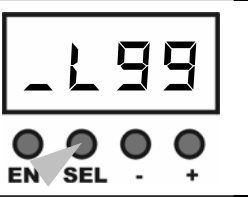
	<p>Press the + button to get into Static Colour mode</p>
	<p>Select the Hue (colour) using the + and – buttons. Hold down the button to change colour faster.</p>
	<p>Change to Saturation mode using the SEL button</p>
	<p>Select the Saturation (richness of colour) using the + and – buttons. S00=Primary colours. S50=Pastel colours. S99=White</p>

	<p>Change to Luminance (brightness) mode using the SEL button</p>
	<p>Select the Luminance (brightness) using the + and - buttons. L00=Off. L99=Full brightness</p>

➤ Note: although the unit displays 0-99, there are some finer settings in between each full number, so the number will not change every time you press the button.

The unit will remain in static colour mode until you exit STAT mode by pressing ENT.

If you turn off the unit while it is in STAT mode, next time you turn it on it will come back on in STAT mode set to the same colour as you left it.

### Linking units in master-slave mode

You can link multiple units together in Stand Alone mode and they will slave together. Slave units should have ADDR set to 001, the MODE option set to RGB and the MACR option set to OFF (the default options).

➤ Important: Do not connect DMX when units are slaved in stand alone mode. The DMX will conflict with the stand alone information and cause flickering.

### 3 or 4 output mode

Enables or disables the fourth LED output channel.

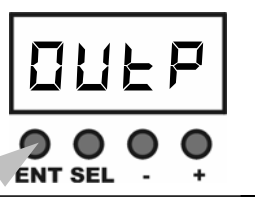
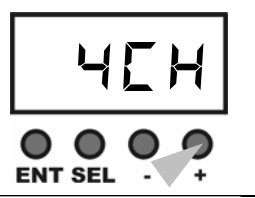
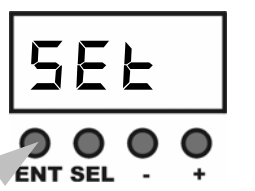
	<p>Keep pressing the ENT button to get to the OUTP option.</p>
	<p>Use the + button to set 4 channel or 3 channel mode. In 3 channel mode the White output is disabled and the unit will use one less DMX channel.</p>
	<p>Press the ENT button to store the output mode.</p>

## DMX control options

To enter the option menu, hold the ENT button for 3 sec. Press ENT to go to the next option, or SEL to go back to the previous option.



## DMX address

Sets the DMX address the unit is to respond to

	<p>Hold down the ENT button to get to the ADDR option.</p>
	<p>Use the three right hand buttons to set the digit above them (hundreds, tens and units)</p>
	<p>Press the ENT button to store the DMX address.</p>

## Play back a Pattern (chase sequence)

	<p>If the unit is in DMX mode showing 001, hold down the SEL button to get into the Stand Alone options</p>
--	---

The unit can store and replay 8 patterns of 16 steps. It is provided with 8 built-in patterns but you can reprogram any or all of these. The 8 built in patterns are:

- 1-Red-Green-Blue fade
- 2-Red-Orange-Green-Cyan-Blue-Magenta fade
- 3-Red with white passing through
- 4-Blue with white passing through
- 5-Red-Green-Blue pastel colour fade
- 6-Purple/Green then Orange/Blue
- 7-Cyan/Blue
- 8-White/Off chase

To play back a pattern, use the following steps. If you don't need to change the Pattern number, time or fade, you can skip those steps.

*Select which pattern you want to play*

	<p>Press the SEL button repeatedly to get to the PATT option. If you go past the PATT option you can press ENT to go back.</p>
	<p>Select the pattern number you want to play back (1-8) using the + and - buttons.</p>



Press the ENT button to store the pattern number

*Set the Step Time for the pattern*



Press the SEL button to get to the TIME option. (you can go back with the ENT button if you go past it)



Use the + and – buttons to select the time duration of each pattern step. You can select 1 S (second), 2 S, 5 S, 15 S, 30 S, 1 M (minute), 2 M, 5 M, 15 M, 30 M, 60 M, SND (sound trig). (M is shown as  $\overline{M}$ )



Press the ENT button to store the step time setting.

DMX	Output
0-31	Select pattern 1
32-63	Select pattern 2
64-95	Select pattern 3
96-127	Select pattern 4
128-159	Select pattern 5
160-191	Select pattern 6
192-223	Select pattern 7
224-255	Select pattern 8

*Macro pattern speed (Channel 2 when in macro mode)*

DMX	Output
0	Fastest speed (1 sec per step)
1-254	Variable speed
255	Slowest speed (60 min per step)

*Macro pattern crossfade (Channel 3 when in macro mode)*

DMX	Output
0	No crossfade (snap)
1-254	Variable crossfade
255	Continuous crossfade

## DMX control values

Red, Green, Blue, White and Dimmer

DMX	Output
0	Off
1-254	Variable output 1-99%
255	Full On

Hue (Channel 1 in HSL mode) – continuous colour mix

DMX	Output
0	Magenta
42	Red
85	Orange
128	Green
170	Cyan
213	Blue
255	Magenta

Saturation (Channel 2 in HSL mode)

DMX	Output
0	Full colours (0% white)
1-254	Variable saturation
255	100% white

Luminosity (dimmer) (Channel 3 in HSL mode)

DMX	Output
0	Off
1-254	Variable brightness 1-99%
255	Full On

Macro control channel (set MACR option to ON to enable)

DMX	Output
0-127	Normal operation
128-255	Macro mode enabled

Macro pattern select (Channel 1 when in macro mode)

Set the Fade Rate for the pattern

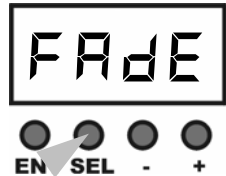
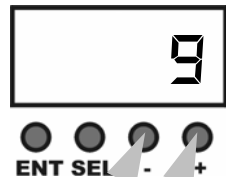
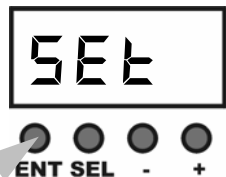
	<p>Press the SEL button to get to the FADE option (you can go back with the ENT button if you go past it)</p>
	<p>Use the + and – buttons to select the amount of fade between steps. 0=Snap. 9=Maximum fade</p>
	<p>Press the ENT button to store the fade setting.</p>

Start the playback

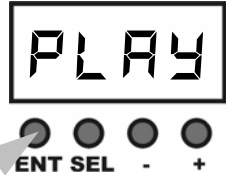
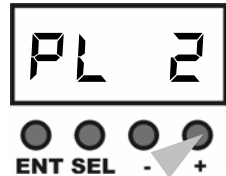
	<p>Press the ENT or SEL button repeatedly until you get to the PLAY option.</p>
	<p>Press the + button to start playback of the pattern.</p>

➤ You do not need to set the PATT, TIME and FADE options each time – the unit will remember the last settings. TIME and FADE are remembered separately for each Pattern.

Go straight to the PLAY option to play a pattern with its previous settings.

The unit will remain in playback mode until you exit PLAY mode by pressing ENT.

If you turn off the unit while it is in PLAY mode, next time you turn it on it will come back on in PLAY mode running the same pattern as you left it.

## DMX control channels

Outp	Mode	1	2	3	4	5	6	Note
3CH	RGBD	R	G	B	D	m	-	
3CH	RGB	R	G	B	m	-	-	No master dimmer
3CH	HSL	H	S	L	m	-	-	
4CH	RGBD	R	G	B	W	D	m	
4CH	RGB	R	G	B	W	m	-	-DEFAULT MODE-
4CH	HSL	H	S	L	m	-	-	
*	SNGL	D	-	-	-	-	-	
*	*	Pa	Sp	Xf	?	?	?	MACR ON, Macro channel > 50%

R=Red, G=Green, B=Blue, W=White, D=Dim

H=Hue, S=Saturation, L=Luminance

m = becomes Macro control channel if MACR option is ON, otherwise unused

Pa=Pattern select, Sp=Speed select, Xf=Crossfade select

? = in macro mode, macro channel will remain where it was before.

Note: In HSL mode, the white channel is controlled using the Saturation control (0=off, 100%=full). Saturation also adjusts the RGB channels to give optimum pastel shades or white output. The RGB channels are controlled using the Hue control. HSL mode is only suitable for controlling RGB and RGBW led fixtures. Fixtures using all-one-colour or amber LEDs should be controlled in SNGL or RGB modes.

## Operation in DMX mode

In its normal mode, the unit is controlled by four DMX channels:

1	Red
2	Green
3	Blue
4	White

You set the base DMX address using the ADDR option (hold the left hand button for 3 sec).

The display will show the base DMX address, with a rotating status symbol when DMX is being received.

The following options affect DMX operation:

- OUPP may be set to 4 channel or 3 channel. "3CH" disables the White channel and reduces the DMX channel usage to 4.
- MODE may be set to RGBD, RGB, HSL or SNGL. RGB disables the dimmer channel. HSL changes the control mode to Hue (colour), saturation (depth of colour) and Luminance (intensity). SNGL makes the unit a single channel dimmer with all outputs controlled by one DMX channel.



The following table shows how the DMX control channels are used in the different configurations.

## Recording a Pattern (chase sequence)

	<p>If the unit is in DMX mode showing 001, hold down the SEL button to get into the Stand Alone options</p>
---	---

To record a pattern, use the following steps. If you don't need to change the Pattern number, you can skip those steps.

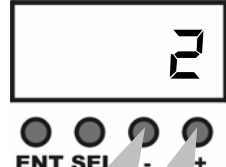
*Select the pattern you want to record*

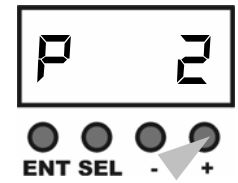
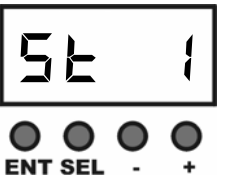

	<p>Press the SEL button repeatedly to get to the PATT option. If you go past the PATT option you can press ENT to go back.</p>
	<p>Select the pattern number you want to record (1-8) using the + and - buttons.</p>
	<p>Press the ENT button to store the pattern number</p>

*Enter Record Mode*

	<p>Press the ENT button once to get to the REC option. If you go past the REC option you can press SEL to go back.</p>
	<p>Press the + button to start recording the pattern. The display shows the Pattern number you are recording.</p>
	<p>The display shows the the step number.</p>

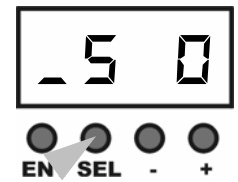
*Set the output for the first step*

	<p>Select the Hue (colour) for the first step using the + and – buttons. Hold down the button to change colour faster.</p>
	<p>Change to Saturation mode using the SEL button</p>

	<p>Press the + button to clear the pattern.</p>
	<p>Hold down the ENT button to leave the menu mode, or use ENT and SEL to select another option.</p>

**Demo mode**

Plays back a demo sequence. The unit will play back each of its 8 internal patterns eight times, then go onto the next pattern. If the user has changed the patterns, the user's patterns will be played.

This is a good way to play back a single long sequence if required. Each pattern uses its own Time, Fade and Offset settings as programmed.

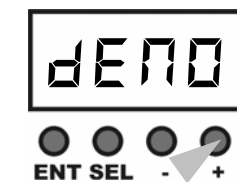
	<p>Press the SEL button repeatedly to get to the DEMO option.</p>
	<p>Press the + button to enter Demo mode. Press any button to end Demo mode.</p>



If you turn off the unit while it is in DEMO mode, next time you turn it on it will come back on in DEMO mode.



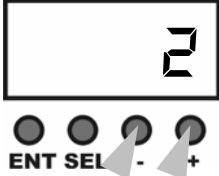

### Clearing a Pattern (chase sequence)

If the unit is in DMX mode showing 001, hold down SEL to get into the menu mode.

The CLR option will reload the factory default pattern into the currently selected PATT number.

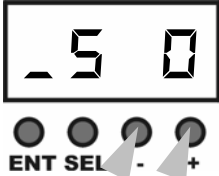
	<p>Press the SEL button repeatedly to get to the PATT option. If you go past the PATT option you can press ENT to go back.</p>
	<p>Select the pattern number you want to clear (1-8) using the + and - buttons.</p>
	<p>Press the ENT button to store the pattern number</p>
	<p>Press the SEL button repeatedly to get to the CLR option. If you go past the CLR option you can press ENT to go back.</p>

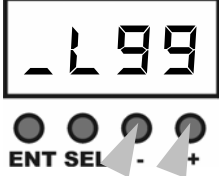
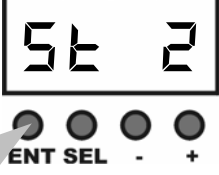
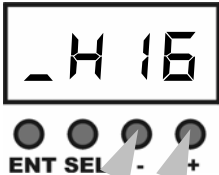
	<p>Select the Saturation (richness of colour) for the step using the + and - buttons. S00=Primary colours. S50=Pastel colours. S99=White</p>
	<p>Change to Luminance (brightness) mode using the SEL button</p>
	<p>Select the Luminance (brightness) for the step using the + and - buttons. L00=Off. L99=Full brightness</p>
	<p>Press the ENT button to store the step. The display shows the next step number.</p>
<p><i>Set the output for the other steps</i></p>	
	<p>Select the Hue, Saturation or Luminance for the second step as before. Press ENT to save. Repeat this for up to 16 steps.</p>

*Set the end of the pattern*

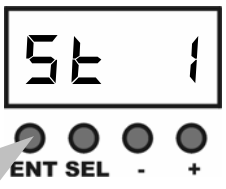
	<p>To End the pattern, hold down the SEL button. The display shows END. If you want to add another step instead of the END step, press SEL to select H S or L.</p>
	<p>Press the ENT button to store the END step. The unit will go back to step 1. You can move through the steps to check them by pressing ENT.</p>

*Finish recording and playback your pattern*

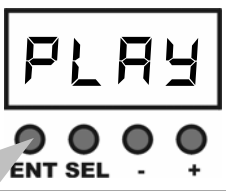
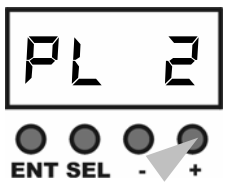

	<p>Hold down the ENT button to exit Record mode. The unit moves on to PLAY mode automatically.</p>
	<p>To run the pattern you have just programmed, press + to start playback. See previous section to set the Time and Fade options.</p>

➤ You do not need to set the PATT number each time – if you go straight to the REC option, the unit will record to whichever pattern number was last used.

**Advanced playback using Offset**

If you have multiple slaved units, Offset can be used to generate a rippling chase across the slaved units, for example if you have 4 slaved units and you set offset to 4, when the first unit is on step 1, the second unit will be on step 2, the third on step 3 and the fourth unit will be on step 4. This allows you to create complicated chase patterns without lots of programming.

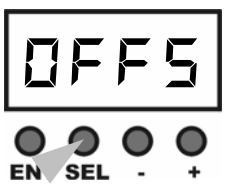
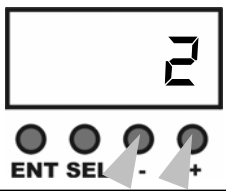
Offset can be set individually for each pattern. It will be set for the currently selected pattern. Select the Pattern number you want to change before you select the Offset option.

	<p>Press SEL until you get to the OFFS option.</p>
	<p>Select the offset value (1-4) using the + and – buttons.</p>
	<p>Press the ENT button to store the offset value.</p>

➤ If you are using Offset, you need to set the DMX addresses of the slaved units as follows: Unit 1 should be set to DMX addr 001, unit 2 to 005, unit 3 to 009, unit 4 to 013. Further units should repeat from 001.